

PRESA DI CONNESSIONE PROTETTA PER FISSAGGIO A PARETE PROTECTED CONNECTION SOCKET FOR WALL FIXING

Dati tecnici

Technical data





- Poli - Poles	2P+E
- Corrente e tensione nominale - Rated current and voltage	16A-250V
- Temperatura massima di funzionamento (IEC) - Maximum operating temperature (IEC)	T120
- Grado di protezione - Protection index	IP66
- Cat. sovratensione / Grado di inquinamento - Impulse withstand cat. / Pollution degree	III / 2

Caratteristiche

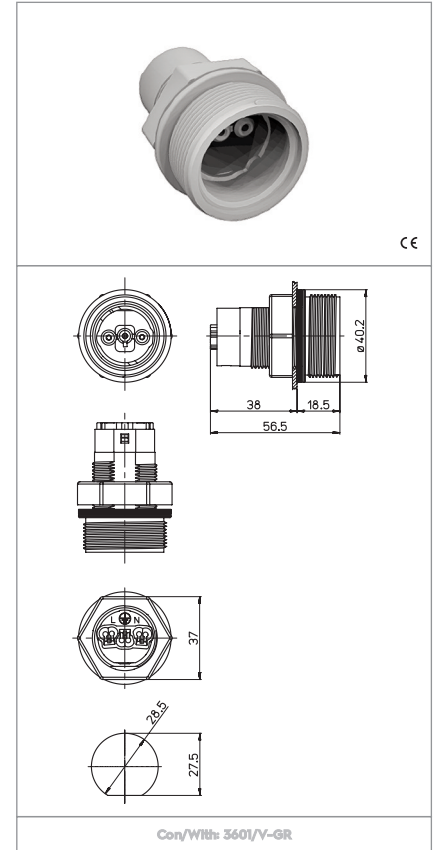
Characteristics

- Corpo in poliammide grigio
– Grey polyamide body
- Contatti in ottone stagnato
– Tin plated brass contacts



 fissaggio con dado fixing with nut	 serrafilo automatico a 2 fori push-wire terminals with 2 holes	 sezione conduttore rigido rigid conductor section	 spelatura cavetti rigidi rigid wires stripping
 adatto per tensione di accensione ad impulsi fino a... suitable for impulse ignition voltage up to...	IP66 protetto IP66 IP66 protected		

Marchi di qualità

Quality marks

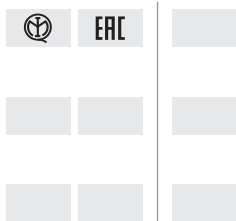

Direttive Europee

European directives

Conforme "RoHS"
"RoHS" compliant
Non soggetto alla "RAEE"
Not subject to "WEEE"

Pesi e confezioni

Weights and packaging

Art. Codice prodotti Product references	g Peso netto Net weight	n° pz per sacco per bag	n° pz per scatola per box	n° pz per cartone per carton
3602/A-GR	34		100	

Note

- La temperatura massima di funzionamento T è la massima temperatura ambiente alla quale il connettore può funzionare con il valore di corrente nominale indicato (EN/IEC61984). Limite di temperatura inferiore / superiore è: -10 °C / +150 °C (EN/IEC61984).

Notes

- The maximum operating temperature T is the maximum ambient temperature for the connector working at the rated current value indicated (EN/IEC61984). Temperature lower/upper limits: -10 °C / +150 °C (EN/IEC61984).