

EPW024.68

SCATOLA DI DERIVAZIONE IP68 A 4 VIE CON MORSETTO 5P IP68 JUNCTION BOX 4 WAYS WITH 5P TERMINAL BLOCK

Dati tecnici

Technical data









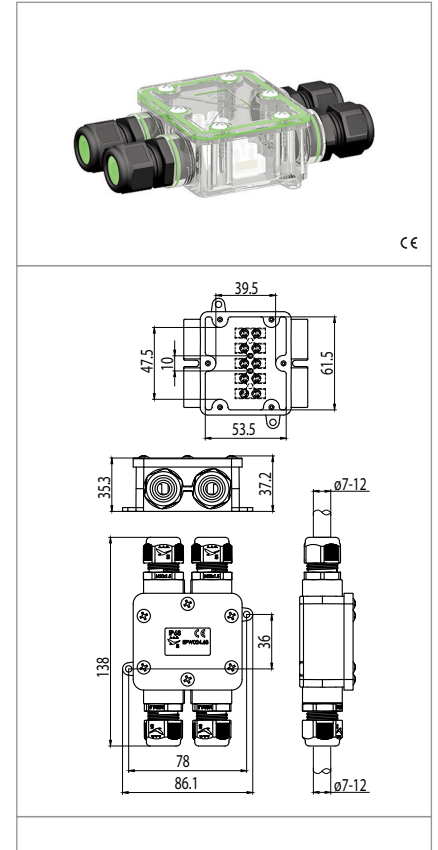

| | |
|---|--------------------------|
| - Poli morsetto - Terminal block poles | 2P+E |
| - Corrente e tensione nominale morsetto - Terminal block rated current and voltage | 32A-450V |
| - Temperatura massima di funzionamento (IEC) - Maximum operating temperature (IEC) | T85 |
| - Grado di protezione - Protection index | IP68 (5bar/3h - EN60529) |

Caratteristiche

Characteristics

- Con morsetto 5P in poliammide PA10 e serrafilo in ottone nichelato
– With PA10 5P terminal block; nichel plated brass alloy contacts
- Corpo scatola di derivazione in policarbonato trasparente
– Junction box body in transparent PC
- Guarnizione planare e guarnizione pressacavi in silicone verde; Gommini pressacavi in TPE verde
– Gaskets in green silicone, cable gland grommets in green TPE
- Coppia serraggio pressacavi e dadi: 2,5Nm
– Glands and nuts torque: 2,5Nm
- Tappo per eventuale chiusura uscita (compreso nella confezione)
– Closing cap for output to be used if needed (provided within the pack)



| | | | |
|--|--|---|--|
|  fissaggio con vite screw fixing |  1IN 3OUT con ingresso fino a 1,5mm2 input cable up to 1,5mm2 |  1IN 2OUT con ingresso 2,5mm2 input cable up to 2,5mm2 |  |
|  serrafilo con vite e morsetto screw terminals |  8 spelatura cavetti flessibili flexible wires stripping |  0,5-2,5 serrafilo con vite e morsetto screw terminals |  entrata: vite uscita: vite input side: screw output side: screw |
|  0,5-15 serrafilo con vite e morsetto screw terminals |  8 spelatura cavetti flessibili flexible wires stripping | | |

Marchi di qualità

Quality marks

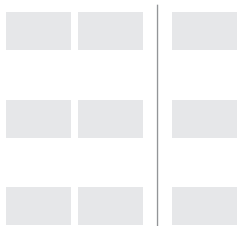

Direttive Europee

European directives

Conforme "RoHS"
"RoHS" compliant
Non soggetto alla "RAEE"
Not subject to "WEEE"

Pesi e confezioni

Weights and packaging

| Art. Codice prodotti Product references | g Peso netto Net weight | n° pz per sacco per bag | n° pz per scatola per box | n° pz per cartone per carton |
|---|-------------------------------|-------------------------------|---------------------------------|------------------------------------|
| EPW024.68 | 136,7 | | | |
| | | | | |
| | | | | |
| | | | | |
| | | | | |

Note

- La temperatura massima di funzionamento T è la massima temperatura ambiente alla quale il connettore puo' funzionare con il valore di corrente nominale indicato (EN/IEC60998). Limite di temperatura inferiore / superiore é: -40 °C / +85 °C (EN/IEC60998).

Notes

- The maximum operating temperature T is the maximum ambient temperature for the connector working at the rated current value indicated (EN/IEC60998). Temperature lower/upper limits: -40 °C / +85 °C (EN/IEC60998).